

EVS-2028 Ordering Guide

Choose one of the package options shown, *or....create your own!*

System Components	Table Risers	Floor Stand
H: 37" x W: 30" x D: 21.5"	H: 8" x W: 30" x D: 21.5"	H: 32" x W: 30" x D: 21.5"
Model EVS-2028	Model SW-2028	Model FS-2028
		<i>Table riser optional Height is adjustable 32" - 48"</i>
	Model TS-2028	
	Model 1F-2028	
	Model 2F-2028	

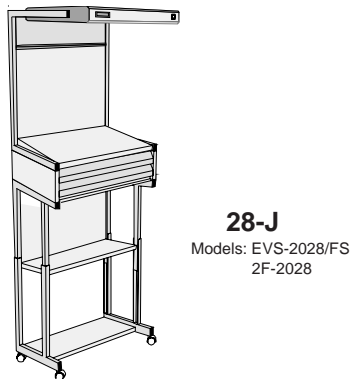
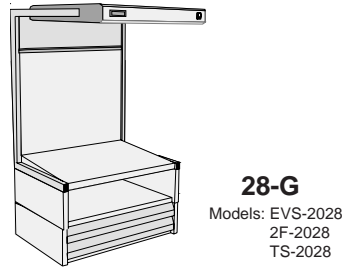
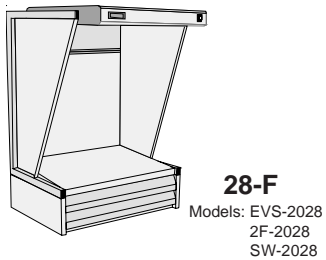
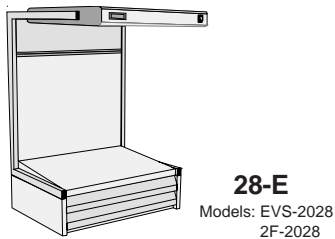
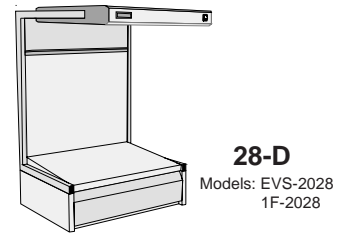
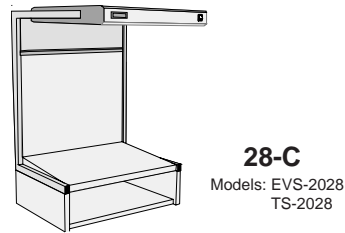
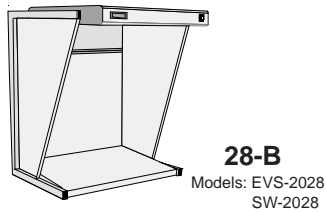
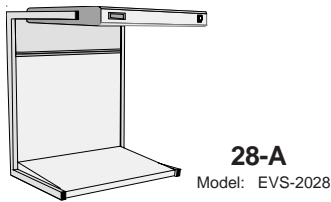

GTI Graphic Technology, Inc.